

LX-20 Friction Feeder

Overview

Streamfeeder's LX-20 is packed with unique features that make it the best value in the marketplace today! Tool-less, quick make ready adjustments and versatility makes this the perfect entry level packaging feeder for increasing productivity at an affordable price.

Feed a wide variety of flat and multi-thickness products into shrink wrappers, poly baggers, banders, collators, case packers, boxes, cartons, totes and more. Operates on-demand, single shot or batched set, or in continuous feed mode.

Standard Features

- Repositionable feed belts
- Independent side guide positioning
- Extended guide rails into the discharge to keep products from skewing
- Two independent separators that can be easily repositioned throughout the width of the feeder
- Tool-less discharge angle adjustment
- Self-adjusting discharge hold down
- Variable speed control
- Batch counting capabilities up to 99 pieces
- Miss-detect fault output
- Timeout stop
- High performance photo sensors
- Two-wire host interface
- Continuous Mode Operation

Applications

- Cartoners
- Case Packers
- Collators
- Envelope Inserters
- Flow Wrappers
- Order Fulfillment
- Poly Baggers
- Shrink Wrappers

Products

- Backer Board
- Booklets
- Brochures
- Cardstock
- Collapsed Cartons
- Envelopes
- Folded Documents
- Folders
- Literature
- Manuals
- Retail Signage
- Sheet Paper

Contact our experienced sales team today for a comprehensive review of your application/product and see how our LX-20 can benefit your company.

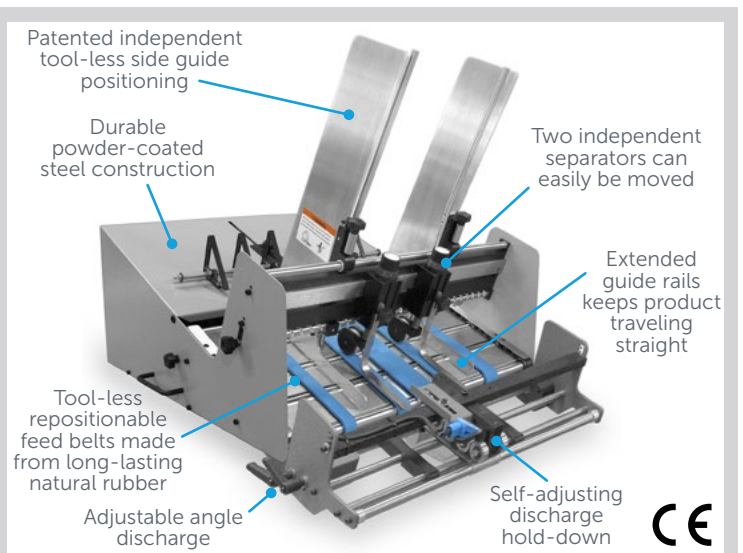

Specifications

Maximum Product Size	20" wide x 18" long (508 x 457 mm)
Minimum Product Size	2.5" wide x 3" long (64 x 76 mm)
Min/Max Product thickness	.003" - 1.0" (.076 - 25.4 mm)
Belt Speed	4,000 in/min (101.6 m/min)
Batch Size	1 - 99
Utilities	115/230vac, 50/60Hz, 5A
Weight	99 lbs. (45 kg)
Warranty	One year limited
Other sizes and thickness capabilities available.	

Hayssen | Rose Forgrove | Sandiacre | Schib | Simionato | Streamfeeder | Symach | Thiele

Streamfeeder - BW Flexible Systems

315 27th Avenue Northeast | Minneapolis, MN 55418 USA

+1 (763) 502-0000 Streamfeeder.com

2022.02

barrywehmiller
bw
betterworld